

2600 Imp Gal VCT

REV.
P0

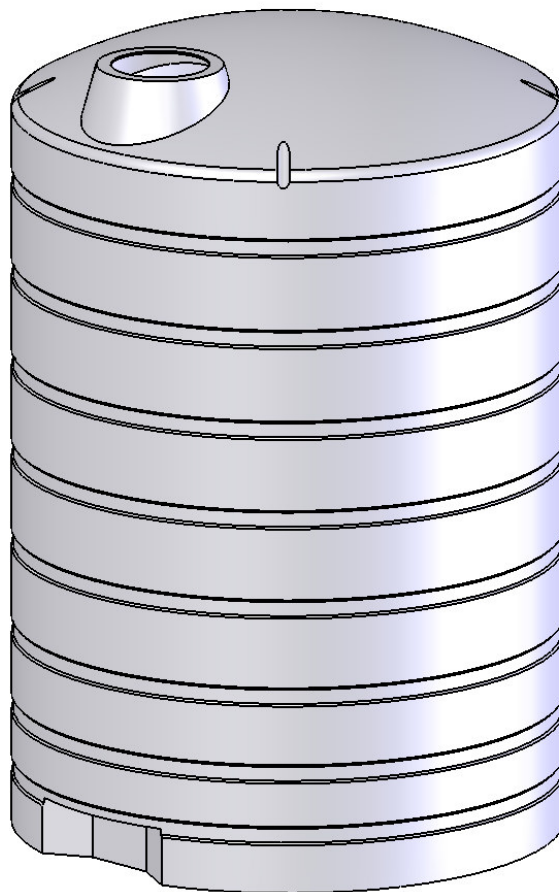
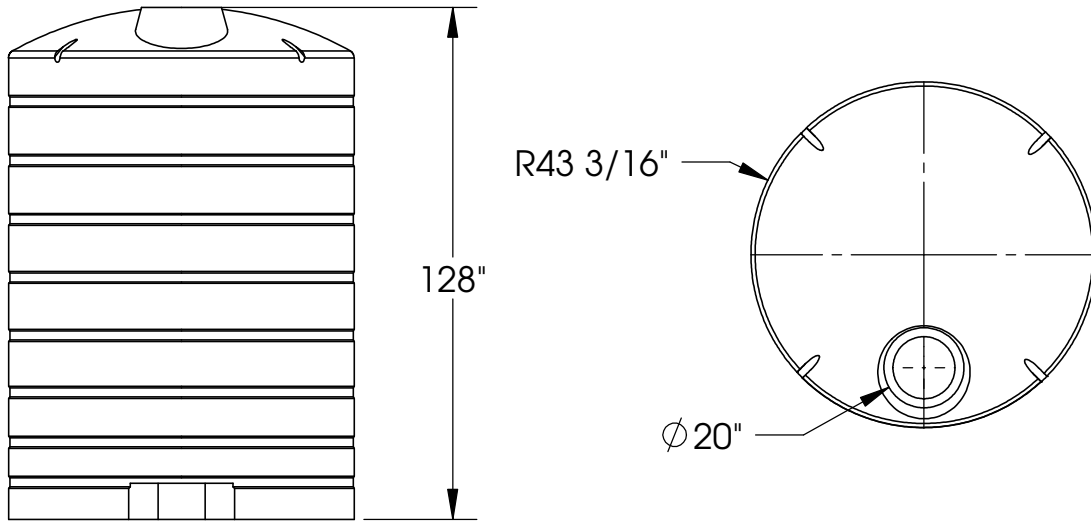

Imp Gal	2600
Litres	11830
US Gal	3125

Shrinkage: 3% / All dimensions are ± 1



2530-39th Street N.
Lethbridge, AB T1H 5J2

FLEXA HOPPER PLASTICS LTD